

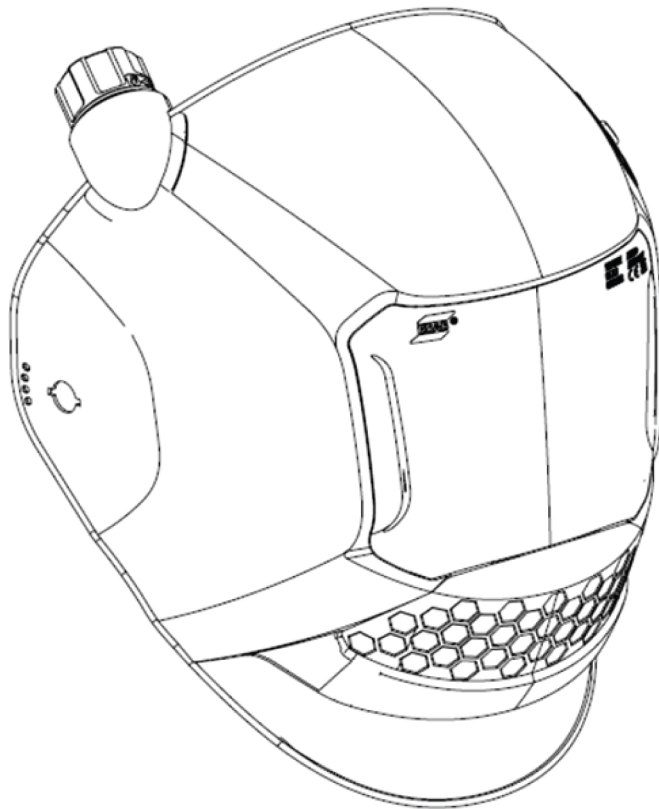

Savage A50Air LUX



Auto Darkening Welding Helmet

Instruction manual and Spare parts list

PLEASE READ AND UNDERSTAND ALL INSTRUCTION BEFORE USE. RETAIN THIS MANUAL FOR FUTURE REFERENCE.

Complete User Manual at:

Manual Number: 0448 554 001
Revision Date: 2025-09-16
Revision Number: D
Language: English UK





EU DECLARATION OF CONFORMITY

According to the Council Directive (EU) 2016/425 entering into force 9 March 2016
This declaration of conformity is issued under the sole responsibility of the manufacturer.

Type of equipment

Welding Helmet

Type designation

Savage A50 LUX 0700 500 950
Savage A50 Air LUX 0700 500 951

Brand name or trademark

ESAB

Manufacturer or his authorized representative established within the EEA**Name, address, and telephone No:**

ESAB Group (UK) Ltd
322 High Holborn, London, WC1V 7PB
Great Britain
Phone: +44 1992 768515

The following harmonized standard in force within the EEA has been used in the design:

EN 166:2001 Personal eye protection - Specifications
EN 175:1997 Personal protection. Equipment for eye and face protection during welding and allied processes
EN 379:2009 Personal eye protection – Automatic welding filters
ISO 16321-2:2021 – Eye and face protection for occupational use – Part 2: Additional requirements for protectors used during welding and related techniques

EC Type Examination Certificate and Test Certificates issued by:

DIN CERTCO GmbH
Tillystraße 2, 90431
Nürnberg, Germany
Notified body: 0196
performed and issued the EU type-examination certificate: C7293ESAB/R0, C7294ESAB/R0,
C7295ESAB/R0, C7299ESAB/R0

By signing this document, the undersigned declares as manufacturer, or the manufacturer's authorized representative, that the equipment in question complies with the safety requirements stated above.

Date

Signature

Position

2024-04-09

Peter Burchfield

General Manager/
Equipment Solutions

CE 2024

TABLE OF CONTENTS

1	SAFETY	4
1.1	Meaning of symbols	4
1.2	Safety instructions for auto-darkening welding helmet and filter	4
1.3	Safety precautions	5
1.4	California proposition 65 warning	9
2	INTRODUCTION	10
2.1	Equipment	10
2.2	Auto-darkening filter marking explanation	10
2.3	Respiratory certifications	11
3	TECHNICAL DATA	12
3.1	Shade guide	13
4	INSTALLATION	15
4.1	Installing the battery	15
4.2	Installing the magnifying lens	15
4.3	Adjusting the fit of the helmet	16
4.4	Attaching and securing the PAPR hose	16
4.5	Donning the helmet	16
5	OPERATION	18
5.1	Battery indicator	18
5.2	Selecting grind mode	18
5.3	Selecting shade	18
5.4	Selecting sensitivity	19
5.5	Selecting delay time	19
5.6	Selecting cut mode	19
5.7	Turning the LED work light on/off	20
6	MAINTENANCE	21
6.1	Replacing the front cover lens	21
6.2	Replacing the inside cover lens	21
6.3	Replacing the Auto-Darkening Filter (ADF)	22
6.4	Replacing the LED work light battery	22
6.5	Cleaning the auto-darkening welding helmet	22
7	TROUBLESHOOTING	23
	SPARE PARTS	24

1 SAFETY



WARNING!

Read and understand this entire manual and your employer's safety practices before installing, operating, or servicing the equipment.

While the information contained in this manual represents the Manufacturer's best judgment, the manufacturer assumes no liability for its use.



WARNING!

- **INGESTION HAZARD:** This product contains a button cell or coin battery.
- **Death** or serious injury can occur if ingested.
- A swallowed button cell or coin battery can cause **Internal Chemical Burns** in as little as **2 hours**.
- **KEEP** new and used batteries **OUT OF REACH OF CHILDREN**.
- **Seek immediate medical attention** if a battery is suspected to be swallowed or inserted inside any part of the body.



1.1 Meaning of symbols

As used throughout this manual: Means Attention! Be Alert!



DANGER!

Means immediate hazards which, if not avoided, will result in immediate, serious personal injury or loss of life.



WARNING!

Means potential hazards which could result in personal injury or loss of life.



CAUTION!

Means hazards which could result in minor personal injury.



WARNING!

Before use, read and understand the instruction manual and follow all labels, employer's safety practices and Safety Data Sheets (SDSs).



1.2 Safety instructions for auto-darkening welding helmet and filter

Before use

The auto-darkening welding helmet comes assembled, but before it can be used, perform the following:

- Adjust the helmet to fit the user properly.
- Check battery surfaces and contacts and clean them if necessary.
- Verify that the battery is in good condition and properly installed.
- Set up for delay time, sensitivity, and shade number for your application.

Usage

- The helmet is not suitable for laser welding.

- Never place the helmet and auto-darkening filter on a hot surface.
- The helmet will not protect against severe impact hazards.
- The helmet will not protect against explosive devices or corrosive liquids.
- Should the helmet not darken upon striking an arc, stop welding immediately and contact ESAB.
- Do not immerse the filter in water.
- The materials which may come into contact with the wearer's skin can cause allergic reactions in some circumstances.
- The filter shall only be used in conjunction with the inner cover lens.

Maintenance

- The helmet should be stored in a cool, dry, and dark place. Remove the battery before long-time storage.
- Protect filter from contact with liquid and dirt.
 - Clean the filter surface regularly by using clean water and a lint-free or microfiber cloth; do not use strong cleaning solutions. Always keep the sensors and solar cells clean using a clean lint-free tissue or microfiber cloth.
 - Regularly replace the cracked/scratched/pitted front cover lens. Avoid setting the helmet down directly on the cover lens to avoid premature damage to the cover lens.
- Never open or tamper with the filter. There are no user-serviceable parts inside.
- Do not make any modifications to either the filter or helmet, unless specified in this manual.
- Only use replacement parts that are specified in this manual.
- Unauthorized modifications and replacement parts will void the warranty and expose the operator to personal injury.
- Do not use any solvents on the filter screen or helmet components.

1.3 Safety precautions



WARNING!

These Safety Precautions are for your protection. They summarise precautionary information from the references listed in Additional Safety Information section. Before performing any installation or operating procedures, be sure to read and follow the safety precautions listed below as well as all other manuals, material safety data sheets, labels, etc. Failure to observe Safety Precautions can result in injury or death.



PROTECT YOURSELF AND OTHERS

Some welding, cutting and gouging processes are noisy and require ear protection. The arc, like the sun, emits ultraviolet (UV) and other radiation and can injure skin and eyes. Hot metal can cause burns. Training in the proper use of the processes and equipment is essential to prevent accidents. Therefore:

1. Wear a welding helmet fitted with a proper shade of filter to protect your face and eyes when welding or watching.
2. Always wear safety glasses with side shields in any work area, even if welding helmets face shields and goggles are also required.
3. Use a face shield fitted with the correct filter and cover plates to protect your eyes, face, neck and ears from sparks and rays of the arc when operating or observing operations. Warn bystanders not to watch the arc and not to expose themselves to the rays of the electric-arc or hot metal.
4. Wear flameproof gauntlet type gloves, heavy long-sleeve shirt, cuff less trousers, high-topped shoes and a welding helmet or cap for protection, to protect against arc rays and hot sparks or hot metal. A flameproof apron may also be desirable as protection against radiated heat and sparks.
5. Hot sparks or metal can lodge in rolled up sleeves, trouser cuffs, or pockets. Sleeves and collars should be kept buttoned and open pockets eliminated from the front of clothing.
6. Protect other personnel from arc rays and hot sparks with a suitable non-flammable partition or curtains.

7. Use goggles over safety glasses when chipping slag or grinding. Chipped slag may be hot and can fly far. Bystanders should also wear goggles over safety glasses.



FIRES AND EXPLOSIONS

Heat from flames and arcs can start fires. Hot slag or sparks can also cause fires and explosions. Therefore:

1. Protect yourself and others from flying sparks and hot metal.
2. Remove all combustible materials well away from the work area or cover the materials with a protective non-flammable covering. Combustible materials include wood, cloth, sawdust, liquid and gas fuels, solvents, paints and coatings paper, etc.
3. Hot sparks or hot metal can fall through cracks or crevices in floors or wall openings and cause a hidden smoldering fire or fires on the floor below. Make certain that such openings are protected from hot sparks and metal.
4. Do not weld, cut or perform other hot work until the work piece has been completely cleaned so that there are no substances on the work piece which might produce flammable or toxic vapors. Do not do hot work on closed containers, they may explode.
5. Have fire extinguishing equipment handy for instant use, such as a garden hose, water pail, sand bucket, or portable fire extinguisher. Be sure you are trained in its use.
6. Do not use equipment beyond its ratings. For example, an overloaded welding cable can overheat and create a fire hazard.
7. After completing operations, inspect the work area to make certain there are no hot sparks or hot metal which could cause a later fire. Use fire watchers when necessary.



ELECTRICAL SHOCK

Contact with live electrical parts and ground can cause severe injury or death. DO NOT use AC welding current in damp areas, if movement is confined, or if there is danger of falling. Therefore:

1. Be sure the power source frame (chassis) is connected to the ground system of the input power.
2. Connect the workpiece to a good electrical ground.
3. Connect the work cable to the workpiece. A poor or missing connection can expose you or others to a fatal shock.
4. Use well-maintained equipment. Replace worn or damaged cables.
5. Keep everything dry, including clothing, work area, cables, torch/electrode holder and power source.
6. Make sure that all parts of your body are insulated from both the work piece and from the ground.
7. Do not stand directly on metal or the earth while working in tight quarters or a damp area; stand on dry boards or an insulating platform and wear rubber-soled shoes.
8. Put on dry, hole-free gloves before turning on the power.
9. Turn off the power before removing your gloves.
10. Refer to ANSI/ASC Standard Z49.1 for specific grounding recommendations. Do not mistake the work lead for a ground cable.



ELECTRIC AND MAGNETIC FIELDS

May be dangerous. Electric current flowing through any conductor causes localized Electric and Magnetic Fields (EMF). Welding and cutting current creates EMF around welding cables and welding machines. Therefore:

1. Welders having pacemakers should consult their physician before welding. EMF may interfere with some pacemakers.
2. Exposure to EMF may have other health effects which are unknown.

3. Welders should use the following procedures to minimise exposure to EMF:
 - a) Route the electrode and work cables together. Secure them with tape when possible.
 - b) Never coil the torch or work cable around your body.
 - c) Do not place your body between the torch and work cables. Route cables on the same side of your body.
 - d) Connect the work cable to the workpiece as close as possible to the area being welded.
 - e) Keep welding power source and cables as far away from your body as possible.



FUMES AND GASES

Fumes and gases, can cause discomfort or harm, particularly in confined spaces. Shielding gases can cause asphyxiation. Therefore:

1. Keep your head out of the fumes. Do not breathe the fumes and gases.
2. Always provide adequate ventilation in the work area by natural or mechanical means. Do not weld, cut or gouge on materials such as galvanized steel, stainless steel, copper, zinc, lead beryllium or cadmium unless positive mechanical ventilation is provided. Do not breathe fumes from these materials.
3. Do not operate near degreasing and spraying operations. The heat or arc can react with chlorinated hydrocarbon vapors to form phosgene, a highly toxic gas and other irritant gases.
4. If you develop momentary eye, nose or throat irritation while operating, this is an indication that ventilation is not adequate. Stop work and take necessary steps to improve ventilation in the work area. Do not continue to operate if physical discomfort persists.
5. Refer to ANSI/ASC Standard Z49.1 for specific ventilation recommendations.
6. **WARNING:** This product when used for welding or cutting, produces fumes or gases which contain chemicals known to the State of California to cause birth defects and in some cases cancer (California Health & Safety Code §25249.5 et seq.)



CYLINDER HANDLING

Cylinders, if mishandled, can rupture and violently release gas. A sudden rupture of cylinder valve or relief device can injure or kill. Therefore:

1. Locate cylinders away from heat, sparks and flames. Never strike an arc on a cylinder.
2. Use the proper gas for the process and use the proper pressure reducing regulator designed to operate from the compressed gas cylinder. Do not use adaptors. Maintain hoses and fittings in good condition. Follow manufacturer's operating instructions for mounting regulator to a compressed gas cylinder.
3. Always secure cylinders in an upright position by chain or strap to suitable hand trucks, undercarriages, benches, wall, post or racks. Never secure cylinders to work tables or fixtures where they may become part of an electrical circuit.
4. When not in use, keep cylinder valves closed. Have valve protection cap in place if regulator is not connected. Secure and move cylinders by using suitable hand trucks.



MOVING PARTS

Moving parts, such as fans, rotors and belts can cause injury. Therefore:

1. Keep all doors, panels, guards and covers closed and securely in place.
2. Stop engine or drive systems before installing or connecting unit.
3. Have only qualified people remove covers for maintenance and troubleshooting as necessary.
4. To prevent accidental starting of equipment during service, disconnect negative (-) battery cable from battery.
5. Keep hands, hair, loose clothing and tools away from moving parts.

6. Reinstall panels or covers and close doors when service is finished and before starting engine.



**WARNING!
FALLING EQUIPMENT CAN INJURE**

- Only use lifting eye to lift unit. Do NOT use running gear, gas cylinders or any other accessories.
- Use equipment of adequate capacity to lift and support unit.
- If using lift forks to move unit, be sure forks are long enough to extend beyond opposite side of unit.
- Keep cables and cords away from moving vehicles when working from an aerial location.



**WARNING!
EQUIPMENT MAINTENANCE**

Faulty or improperly maintained equipment can cause injury or death. Therefore:

1. Always have qualified personnel perform the installation, troubleshooting and maintenance work. Do not perform any electrical work unless you are qualified to perform such work.
2. Before performing any maintenance work inside a power source, disconnect the power source from the incoming electrical power.
3. Maintain cables, earthing wire, connections, power cord and power supply in safe working order. Do not operate any equipment in faulty condition.
4. Do not abuse any equipment or accessories. Keep equipment away from heat sources such as furnaces, wet conditions such as water puddles, oil or grease, corrosive atmospheres and inclement weather.
5. Keep all safety devices and cabinet covers in position and in good repair.
6. Use equipment only for its intended purpose. Do not modify it in any manner.



**WARNING!
WELDING HELMET CRITERIA**

1. The protection according to Z87.1 is only given if it is ensured that the product is assembled according to the manufacturer's instructions.
2. The eye-protectors against high-speed particles worn over standard ophthalmic spectacles may transmit impacts, thus creating a hazard to the wearer.
3. If the impact letter followed by letter "T", you can use it for protection against high-speed particles at extremes of temperature. If the impact letter does not follow by letter "T", you should only use the eye protector for protection against high-speed particles at room temperature.
4. A visual inspection of the complete protector is necessary before each use.
5. This protector is appropriate for the headform 1-M.
6. Protector can affect the recognition of colours and/or signal light detection.
7. Protectors that have been subject to impact shall not be used and shall be discarded and replaced.
8. If the impact level symbols are not equal on both the lens/filter and the frame, then it is the lower level that shall be assigned to the complete protector.
9. The protections corresponding to the code numbers/letter 7, 9, CH are provided by the complete protector only if the respective symbols are equal on both the lens and the frame.
10. Not suitable for driving and road use.



CAUTION!
ADDITIONAL SAFETY INFORMATION

For more information on safe practices for electric arc welding and cutting equipment, ask your supplier for a copy of “Precautions and Safe Practices for Arc Welding, Cutting and Gouging”, Form 52-529.

The following publications are recommended:

- ANSI/ASC Z49.1 - “Safety in Welding and Cutting”
- AWS C5.5 - “Recommended Practices for Gas Tungsten Arc Welding”
- AWS C5.6 - “Recommended Practices for Gas Metal Arc welding”
- AWS SP - “Safe practices” - Reprint, Welding Handbook
- ANSI/AWS F4.1 - “Recommended Safe Practices for Welding and Cutting of Containers That Have Held Hazardous Substances”
- OSHA 29 CFR 1910 - "Safety and health standards"
- CSA W117.2 - "Code for safety in welding and cutting"
- NFPA Standard 51B, “Fire Prevention During Welding, Cutting, and Other Hot Work”
- CGA Standard P-1, “Precautions for Safe Handling of Compressed Gases in Cylinders”
- ANSI Z87.1, "Occupational and Educational Personal Eye and Face Protection Devices"

1.4 California proposition 65 warning



WARNING!

Welding or cutting equipment produces fumes or gases which contain chemicals known in the State of California to cause birth defects and, in some cases, cancer. (California Health & Safety Code Section 25249.5 et seq.)



WARNING!

This product can expose you to chemicals including lead, which are known to the state of California to cause cancer and birth defects or other reproductive harm. Wash hands after use.

For more information, go to www.P65Warnings.ca.gov.

2 INTRODUCTION

The **Savage A50Air LUX** is an auto-darkening welding helmet intended for use in most welding processes including: oxy fuel cutting; plasma cutting; grinding; GMAW (MIG/MAG); GTAW (TIG); PAW-plasma arc welding; SMAW/MMA (stick) processes.

ESAB has an assortment of welding accessories and personal protection equipment for purchase. For ordering information contact your local ESAB dealer or visit us on our website.

2.1 Equipment

The auto-darkening welding helmet is supplied with:

- Complete welding helmet with integrated LED work-light and headgear
- 2x outer cover lenses (clear)
- 5x inner cover lenses
- Carry bag
- CR2450 ADF battery
- Screwdriver to access ADF battery
- AA alkaline LED work-light battery
- Safety manual

2.2 Auto-darkening filter marking explanation

Welding helmet: 16321 ESAB W15 E 1-M CE

16321	Number of the standard
ESAB	Manufacturer's name
W15	Maximum shade number of welding filter
E	Impact level (120 m/s)
1-M	Head-form size
CE	European Conformity

Front/inside cover lens: ESAB 1 E CE

ESAB	Manufacturer's name
1	Enhanced optical performance
E	Impact level (120 m/s)
CE	European Conformity

Auto-darkening filter: 16321 ESAB W3/5-9/9-13 V1 CE

16321	Number of the standard
ESAB	Manufacturer's name
3	Light state scale number
5-9 /9-13	Dark state scale numbers
CE	European Conformity

This helmet was tested and certified by:

DIN CERTCO Gesellschaft für Konformitätsbewertung mbH

Alboinstrasse 56, 12103 Berlin, Germany

Notified body number 0196

2.3 Respiratory certifications

The Savage A50 LUX helmets, when used in accordance with the manufacturers instructions and the ESAB EPR-X1 (0700500900) or EPR-X1.1 Air blower unit (0700500920), conforms to the following respiratory standard:

EN12941 1998+ A2:2008 TH3P

Module B Notified Body: Vyzkumny ustav bezpecnosti prace, v. v. i., Jeruzalemska 1283/9, 110 00 Praha 1, Czech Republic (Notified body number 1024)

3 TECHNICAL DATA

Dimensions l × w × h	112 × 105 × 9 mm
Weight	775 g (1.71 lb)
Angle dependence of luminous transmittance class	V1
Viewing area	100 × 60 mm (3.94" × 2.36")
Arc sensor	4
Light state	DIN 3
Grind state	DIN 3
Welding mode	Shade no. from 5-8/9-13
Shade control	Internal Variable shade Digital button control
Power on/off	Automatic on/off
Sensitivity control	Low — High Digital button control
UV/IR protection	Up to shade DIN16 at all times
Power supply	Solar cell. Replaceable battery; 1 × CR2450 lithium battery
Switching time	0.07 ms from light to dark
Grinding	Yes
Delay (dark to light)	0.1 ~ 0.9 s digital button control
Low amperage TIG rated	≥ 3 amps
Operating temperature range	-10 „03 65 „034 „10 149 „11)
Storage temperature range	-20 „03 85 „034 „10 185 „11)
Approvals	CE (EN ISO 16321-1:2022 and EN ISO 16321-2:2021); ANSI Z87.1; CSA Z94.3; AS/NZS 1338.1

3.1 Shade guide

Shade numbers

Operation	Electrode size 1/32 in. (mm)	Arc current (A)	Minimum protective shade	Suggested ⁽¹⁾ shade no. (comfort)
Shielded metal arc welding	Less than 3 (2.5)	Less than 60	7	—
	3-5 (2.5-4)	60-160	8	10
	5-8 (4-6.4)	160-250	10	12
	More than 8 (6.4)	250-550	11	14
Gas metal arc welding and flux Cored arc welding		Less than 60	7	—
		60-160	10	11
		160-250	10	12
		250-500	10	14
Gas tungsten arc welding		Less than 50	8	10
		50-150	8	12
		150-500	10	14
Air carbon Arc cutting	(Light)	Less than 500	10	12
	(Heavy)		11	14
Plasma arc welding		Less than 20	6	6 to 8
		20-100	8	10
		100-400	10	12
		400-800	11	14
Plasma arc cutting	(Light) ⁽²⁾	Less than 300	8	8
	(Medium) ⁽²⁾	300-400	9	12
	(Heavy) ⁽²⁾		10	14
Torch brazing		—	—	3 to 4
Torch soldering		—	—	2
Carbon arc welding		—	—	14

Plate thickness

Operation	in.	mm	Suggested ⁽¹⁾ shade no. (comfort)
Gas welding	Under 1/8	Under 3.2	4 or 5
	1/8 to 1/2	3.2 to 12.7	5 or 6
	Over 1/2	Over 12.7	6 or 8
Oxygen cutting	Under 1	Under 25	3 or 4
	1 to 6	25 to 150	4 or 5
	Over 6	Over 150	5 or 6

3 TECHNICAL DATA

⁽¹⁾ As a rule of thumb, start with a shade that is too dark, then go to a lighter shade which gives a sufficient view of the weld zone without going below the minimum. In oxyfuel gas welding or cutting where the torch produces a high yellow light, it is desirable to use a filter lens that absorbs the yellow or sodium line the visible light of the (spectrum) operation.

⁽²⁾ These values apply where the actual arc is seen. Experience has shown that lighter filters may be used when the arc is hidden by the workpiece.

Data from ANSI Z49.1-2005

4 INSTALLATION

4.1 Installing the battery



WARNING!

Keep the battery away from children!

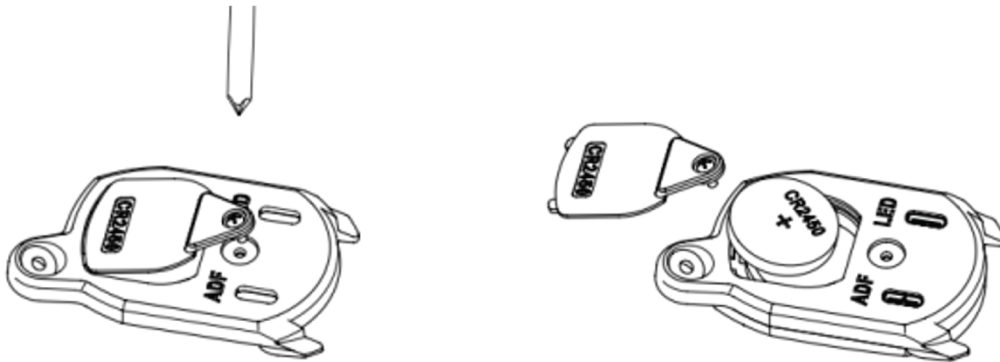

- 1) Remove the battery cover screw located inside the shell, behind the external grind and LED buttons using the included screw driver.
- 2) Slide the battery cover out of the external control case and install the battery properly.
- 3) Slide back the cover after the battery is installed.
- 4) Insert the screw and tighten.

4.2 Installing the magnifying lens

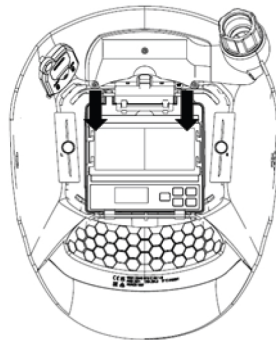

- 1) Slide the magnifying lens down into the magnifier frame on the backside of the Auto-Darkeing Filter (ADF).

4.3 Adjusting the fit of the helmet

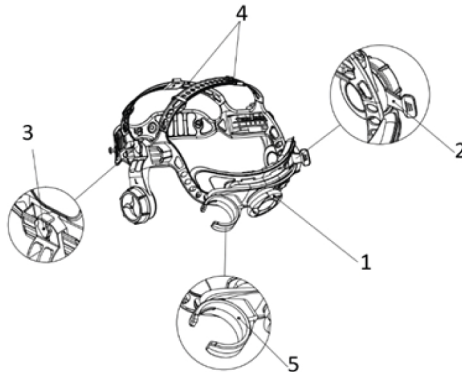

Adjusting the circumference of the headband

- 1) Rotate the knob on the back of the headband to make it larger or smaller. This can be done while wearing the helmet and allows easy micro-level tension adjustment to keep the helmet firmly on the head without it being too tight.
- 2) If the headband is riding too high or too low on the head, adjust the straps which pass over the top of the head:
 - a) Release the end of the band by pushing the locking pin out of the band's hole.
 - b) Slide the two portions of the band to a greater or lesser width as required, and push the locking pin through the nearest hole (4).

Adjusting the distance between the helmet and face

- 1) Press and hold the slider (3) on both sides, to slide the headgear back and forth within the helmet.
- 2) Ensure the slider is locked back into position and that the distance between the lens to both eyes is equal. This avoids issues with uneven Auto-Darkening Filter (ADF) darkness.

Adjusting view angle position

- 1) Locate the tilt adjustment on the right side of the helmet.
- 2) Loosen the right headgear tension knob and adjust the lever forward or back to the desired position (2).
- 3) Retighten the right headgear tension knob.

4.4 Attaching and securing the PAPR hose

- 1) Insert the end of the PAPR hose (provided with the EPR-X1 or EPR-X1.1 PAPR) into the helmet duct and turn the duct locking mechanism to lock it in place.
- 2) Use the hose clamp (see adjustment 5 in "Adjusting the fit of the helmet" chapter) to secure the hose and alleviate tension on the helmet duct.

4.5 Donning the helmet



NOTE!

With the air duct of the product, the user must ensure that the face seal elastic is in contact with the user's face and in front of the user's ears and **not** covering them.

4 INSTALLATION

- 1) The head harness may be adjusted by following the instructions as detailed in the user instructions (adjust the top strap if necessary).
- 2) Fit the head harness on the head and tighten the ratchet by rotating the wheel at the back of the head harness clockwise.
- 3) Use the tab (attached to the face seal) to pull face seal under the chin.
- 4) Make sure that the head cover is pulled down as far as possible at the back of the head.
- 5) If necessary, get help from another person to ensure best-fit and minimal gaps.
- 6) Airflow can be adjusted by rotating adjusting guide.

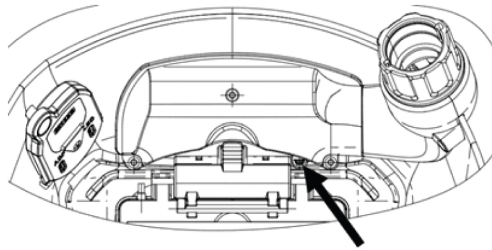



5 OPERATION

5.1 Battery indicator

The auto-darkening filter is powered by a solar cell and a CR2450 lithium battery.

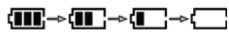
The  symbol shows the current state of the battery and identifies four levels of current capacity:



Replace the battery with a new one when the indicator symbol shows  and the  red LED is continuously illuminated.

5.2 Selecting grind mode



WARNING!



Do not weld while using grind mode!





NOTE!

When the Auto-Darkeing Filter (ADF) is set to grind mode, the lens shade is fixed to shade 3 and cannot be adjusted.

Option 1

- 1) Press the grind button  located on the upper right external side of the helmet shell for two seconds.
- 2) Press the grind button  for two seconds again to return to previous welding shade setting.



Option 2

- 1) Press the  button on the ADF control panel.
- 2) Press the  button to the lowest setting until the shade is set to 3 and the  button is illuminated on the control panel display.

The grind mode indicator is an amber LED on the ADF control panel, and flashes when grind mode is active.

5.3 Selecting shade

- 1) Press the  button on the Auto-Darkeing Filter (ADF) control panel. This will switch the shade mode between shade bank 5-8, shade bank 9-13, or grind.
- 2) Select the shade range between shade bank 5-8 or shade bank 9-13.



- 3) Press the  button to increase the shade number and  to reduce the shade number.
- 4) Select the proper shade number for your welding or cutting process according to "*Shade guide*", page 13.

5.4 Selecting sensitivity

The sensitivity function allows the Auto-Darkeing Filter (ADF) to react appropriately to different welding processes, essentially allowing the ADF to become more or less sensitive to the arc. Sensitivity can only be adjusted while using the welding mode.

Low sensitivity is suitable for using outdoors (excessive ambient/environmental light conditions) and with higher amperage SMAW and FCAW operations.

High sensitivity is suitable for low amperage welding with GTAW or GMAW operations. Under normal welding conditions, a higher sensitivity setting is recommended.



- 1) Press the  button to select sensitivity. The number associated with sensitivity on the LED display symbol flashes.
- 2) Press the  button to adjust the sensitivity. The symbol  on LED display indicates sensitivity level. Level 1 is low sensitivity, and Level 5 is high sensitivity.

5.5 Selecting delay time

The delay function allows the Auto-Darkeing Filter (ADF) to deactivate slower or faster after the weld process has ended, allowing more or less time for the ADF to return to its passive, non-welding state. Delay can be adjusted only while using welding mode.



Level 5 indicates the longest delay setting. The longest time is about 0.9 seconds depending upon welding point temperature and the shade setting. This setting is ideal for welding at high amperage where there is an afterglow from the weld.

Level 1 indicates the shortest delay setting. The shortest time is about 0.1 second depending upon welding point temperature and the shade setting. This setting is ideal for tack welding or production welding with short welds.

- 1) Press the  button. The number associated with delay on the LED display symbol flashes.
- 2) Press the  button to adjust the delay time. This setting adjusts the amount of time the lens takes to lighten after welding. There are 5 levels to adjust delay, with a delay range of 0.1~0.9 seconds.

5.6 Selecting cut mode



Cut mode allows the Auto-Darkeing Filter (ADF) to remain activated at shade 5. The ADF will **not** return to a light state while this mode is active.

- 1)
Press and hold  for two seconds.
- 2)
To revert to standard weld-operating mode, press and hold  for two seconds again.

5.7 Turning the LED work light on/off

The integrated LED light helps when working in low light environments, allowing easier setup and inspection without needing to remove the helmet or exchange tools.

There is a built-in photo sensor that help preserve battery life by switching the light off when ambient light conditions are high.

- 1)
Press the  button located behind the  button on the upper left external side of the helmet shell.

The LED work light function turns on and remains illuminated when the ambient light is low and no welding activity is detected. The LED work light automatically turns off during welding activity or when the ambient light is high.
- 2)
Press the  button again to turn the LED work light off.

6 MAINTENANCE



CAUTION!

Repair and electrical work should be performed by an authorised ESAB service technician. Use only ESAB original spare and wear parts.



NOTE!

Regular maintenance is important for safe and reliable operation.

ESAB recommends a use period of five years. The duration of use depends on various factors such as use, cleaning, storage and maintenance.

Before each use:

- Carefully inspect the auto-darkening welding helmet for worn or damaged parts.

6.1 Replacing the front cover lens

Replace the front cover lens if it becomes scratched or damaged.

Avoid placing the helmet face down when not in use. This helps lengthen the lifespan of the front cover lens.

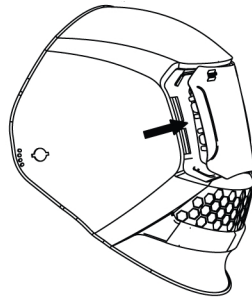

Step 1

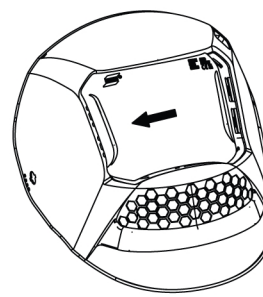

Step 2

- 1) Gently pull the ridges found on the right side (as-worn) of the lens out from the channel.
- 2) Pull and remove the lens from helmet shell.
- 3) Insert the new front cover lens into the left channel first and press to snap in place.
- 4) Insert the new front cover lens into right channel and press to snap into place.

6.2 Replacing the inside cover lens

Replace the inside cover lens if it is damaged.

- 1) Lift the lens at the recess below the Auto-Darkening Filter (ADF).

The inside cover lens flexes upward and releases from the cartridge.

6.3 Replacing the Auto-Darkening Filter (ADF)

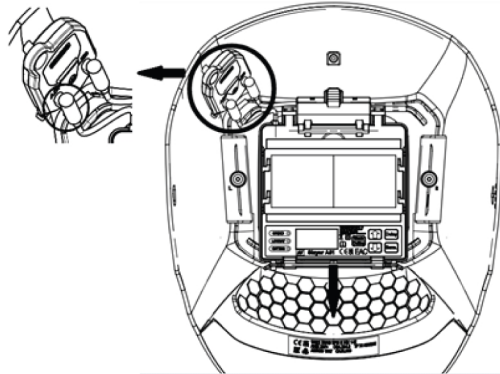

- 1) Remove the USB-C cables connected on the battery case compartment inside the helmet shell and behind the Grind / LED work light buttons.
- 2) Release the ADF retention lock found on the bottom of the ADF.
- 3) Remove the ADF from the shell.
- 4) Install the new ADF into the shell and lock it into place.
- 5) Connect the grind and LED work light USB-C cables into battery case.



CAUTION!

Make sure to connect the cables into the correct receiver. If done incorrectly, the ADF will not operate.

6.4 Replacing the LED work light battery



- 1) Locate the LED battery compartment on the inside of the shell, behind the LED light fixture.
- 2) Open the battery compartment and replace with a fresh AA alkaline battery.

6.5 Cleaning the auto-darkening welding helmet



NOTE!

Do not use strong cleaning solutions.

- 1) Clean the helmet by wiping with a soft, dry cloth.
- 2) Clean the cartridge surfaces regularly.

7 TROUBLESHOOTING

Perform these checks and inspections before sending for an authorised service technician.

Type of fault	Possible cause	Corrective action
Irregular darkening or dimming	Wrong position of the headgear	Make sure the fore/aft adjustment to the headgear is set to the same position on both sides of the headgear. This ensures the correct and equal distance of the Auto-Darkeing Filter (ADF) to the user's eyes.
The ADF does not darken or flicker	The front cover lens is soiled or damaged	Change the cover lens.
	Sensors are soiled	Clean the surface of the sensor.
	Welding current is too low	Increase the sensitivity level.
	Problem with battery	Verify that the battery is in good condition and installed properly. Also, check battery surfaces and contacts and clean if necessary.
Slow response	The operating temperature is too low	Do not use at temperatures below -5 °C or 23 °F.
Poor vision	Front / inside cover lens and/or the filter is soiled	Change lens.
	Insufficient ambient light	Increase ambient light.
	Shade number is incorrectly set	Reset the shade number.
	The protective film is still on the outer cover lens	Ensure the protective film has been removed from the outer cover lens before first use.
Welding helmet slips	Headgear is not properly adjusted	Readjust the headgear.
	Headgear is damaged	Replace the headgear.

APPENDIX

SPARE PARTS

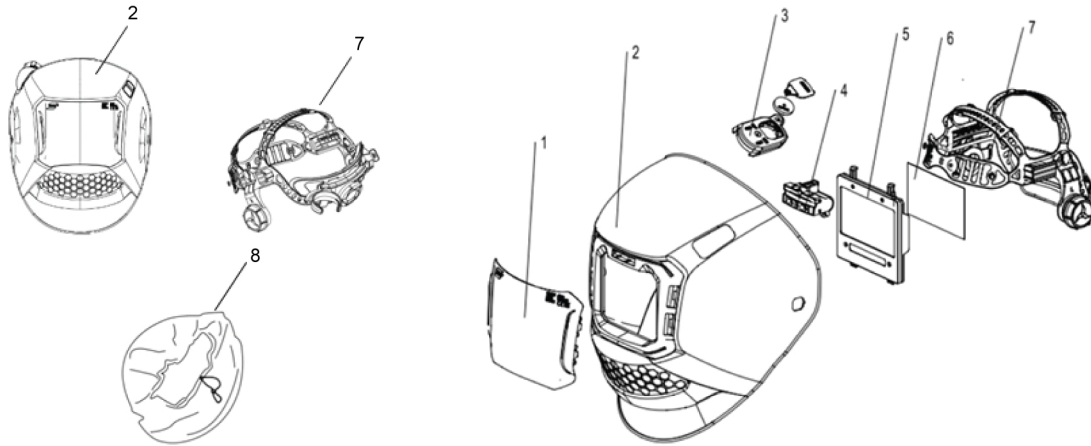

Item	Ordering no.	Denomination
	0700500951	Savage A50Air LUX complete helmet
1	0700500953	Savage A-50LUX Front Cover Lens
	0700500954	Savage A-50LUX Front Cover Lens (HD)
2	0700500959	Savage A-50LUX Helmet Shell
3	N/A	Batteries 1 × CR2450
4	0700500956	Savage A-50LUX LED worklight assembly
5	0700500952	Savage A-50LUX Auto-Darkening Filter (excl. batteries)
6	0700500955	Savage A-50LUX Inside Cover Lens (104 x 64mm)
7	0700600868	Savage A50Air LUX Halo™ Headgear Assembly (Including sweatbands)
8	0700600960	Savage A50Air LUX face seal
	0700600869	Savage A-50LUX Front Sweat Band (forehead) with ESAB Logo
	0700500961	Savage A-50LUX Magnifying Glass +1.0 Diopter
	0700500962	Savage A-50LUX Magnifying Glass +1.5 Diopter
	0700500963	Savage A-50LUX Magnifying Glass +2.0 Diopter
	0700500964	Savage A-50LUX Magnifying Glass +2.5 Diopter



A WORLD OF PRODUCTS AND SOLUTIONS.



ESAB AB
Lindholmsallén 9
Box 8004
402 77 Gothenburg
Sweden
Phone +46 (0) 31 50 90 00

ESAB Corporation
2800 Airport Road
Denton, TX 76207
USA
Phone +1 800 378 8123

ESAB Holdings Ltd
322 High Holborn
WC1V 7PB
London, Great Britain
Phone +44 (0) 1992 768515

For contact information visit esab.com

manuals.esab.com

